

Tool Box



Order No	W	X	Y	Z
*TB10-1	158	105	41	52
TB10-2	203	109	41	56
TB10-3	333	137	66	96
*TB10-4	373	163	72	102



Order No	W	X	Y	Z
TB11-1	382	222	69	95
TB11-2	431	222	84	110



Order No	W	X	Y	Z
TB12-1	382	222	82	151
TB12-2	382	222	82	151
*TB12-3	431	222	94	162

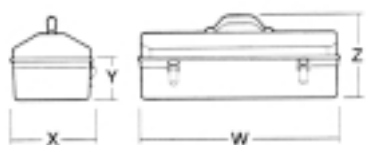
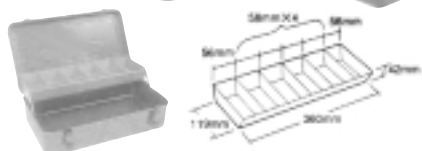

Order No	W	X	Y	Z
TB13-1	304	163	70	123
TB13-2	373	163	72	124
TB13-3	433	167	79	173
*TB13-4	474	173	82	177

Order No	W	X	Y	Z
*TB14-1	429	200	95	199
TB14-2	467	190	99	211
TB14-3	546	220	112	228

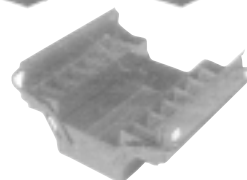
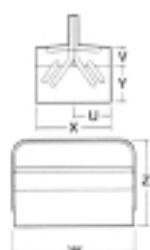
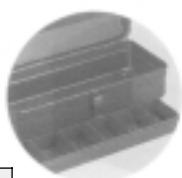
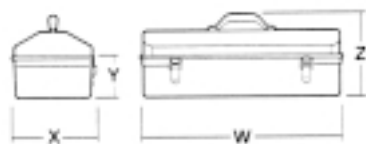
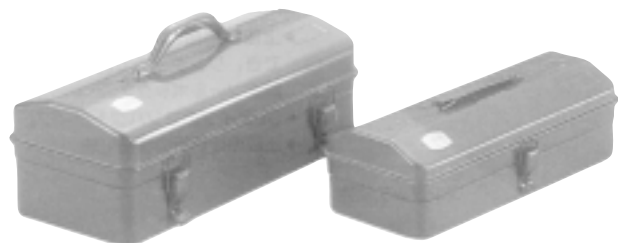

Order No	W	X	Y	Z
TB15-1	373	163	72	124
TB15-2	429	200	95	199

Order No	W	X	V	Y	Z
TB16-1	357	220	54	111	289
TB16-2	417	220	54	111	289
TB16-3	477	220	54	111	289
TB16-4	607	220	54	111	289

Tool Box

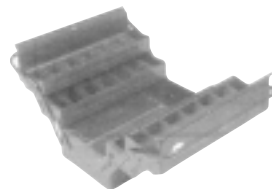
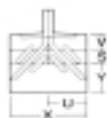

Order No	W	X	V	S	Y	Z
TB17-1	357	220	54	56	111	343
TB17-2	417	220	54	56	111	343
TB17-3	477	220	54	56	111	343



Order No	W	X	Y	Z
*TB18-1	429	200	95	209
TB18-2	467	190	99	211
TB18-3	546	220	112	228

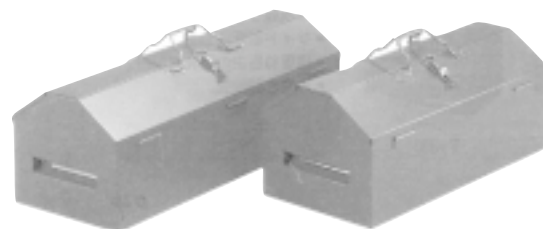
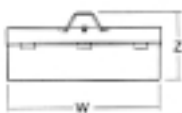
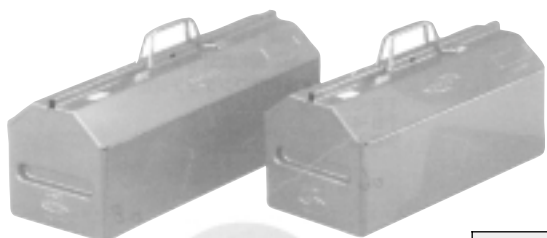

Order No	W	X	Y	Z
TB19-1	464	212	196	261
TB19-2	532	212	196	261
*TB20-3	600	280	185	326
TB20-4	720	280	185	326

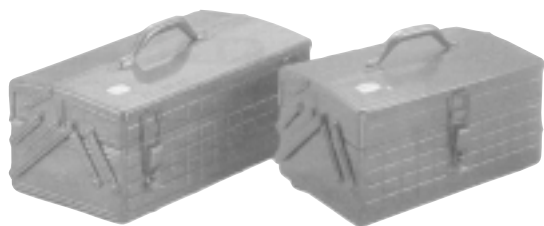
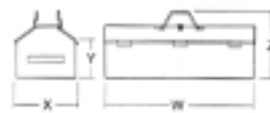
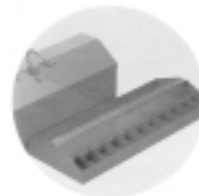

Order No	W	X	V	Y	Z
TB21-1	357	220	54	111	214
TB21-2	417	220	54	111	214



Order No	W	X	V	Y	Z
TB22-1	350	160	46	105	215
*TB22-2	410	160	46	105	215
TB22-3	350	160	46	105	260
*TB22-4	410	160	46	105	260

Tool Box

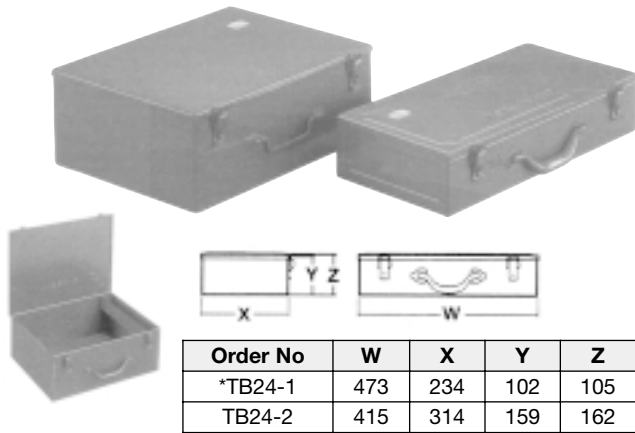

Order No	W	X	Y	Z
*TB24-1	473	234	102	105
TB24-2	415	314	159	162

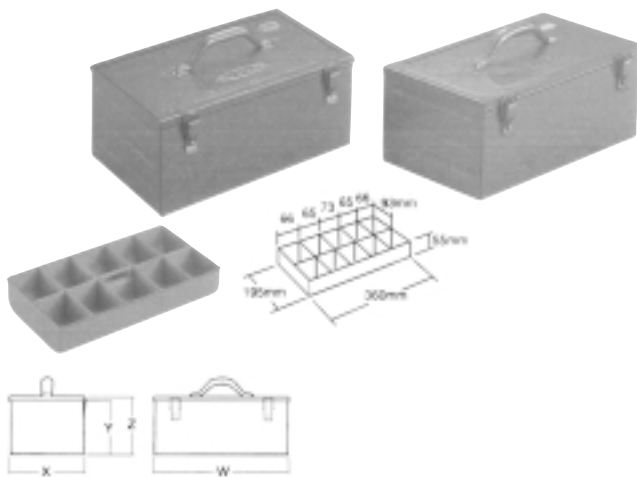

Order No	W	X	Y	Z
*TB25-1	360	217	150	202
TB25-2	410	217	150	202

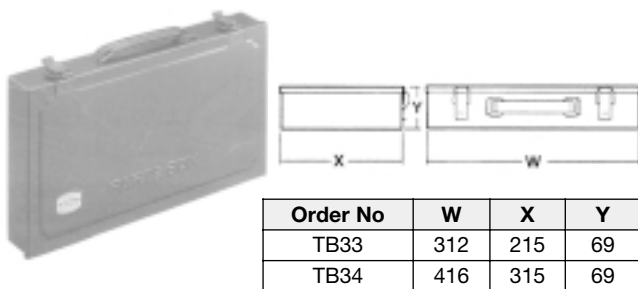

Order No	W	X	Y
TB33	312	215	69
TB34	416	315	69

Order No	W	D	H	No of Drawer Size
TB29	610	420	610	4 No 265 x 390 x 148
TB30	900	42	610	9 No 265 x 390 x 98
TB31	900	420	610	6 No 265 x 390 x 148
TB32	610	420	610	6 No 265 x 390 x 98

Tool Box with Tray & Drawer

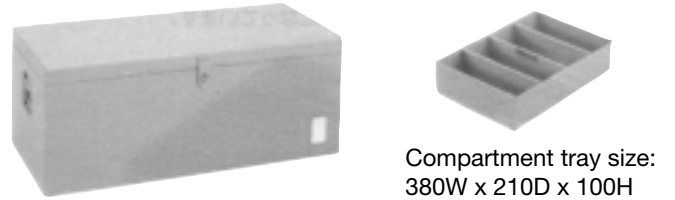

TB 26 without compartment tray
TB 27 with compartment tray

Order No	W	D	H	
TB26-1	470	290	280	w/o compartment
TB26-2	700	290	280	w/o compartment
TB26-3	900	290	280	w/o compartment
TB27-2	700	420	380	c/w compartment
TB27-3	900	420	380	c/w compartment

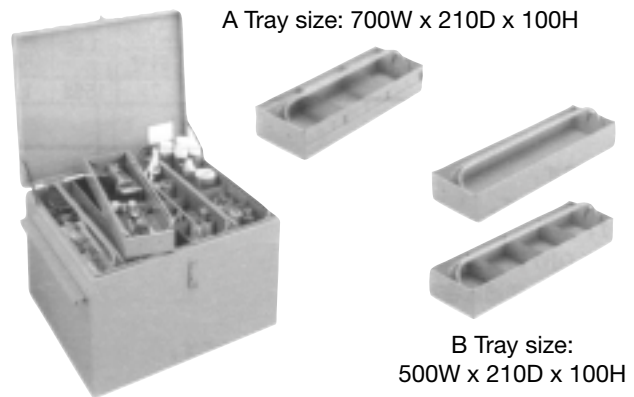

Order No	W	D	H	No of Compartment Tray
TB28-1	914	750	590	4 A Tray
TB28-2	1400	750	590	6 A Tray
TB28-3	1200	420	380	5 B Tray
TB28-4	1400	420	380	6 B Tray



Drawer Size: **TB31**
265W x 390D x 148H(mm)

Drawer Size: **TB32**
265W x 390D x 98H(mm)

Tool Box



50 × 24



50 × 12



100 × 6



50 × 12
100 × 24



100 × 6
50 × 12



100 × 4
50 × 8
100 × 16



50 × 24



100 × 12



100 × 2
50 × 4
50 × 8



50 × 48

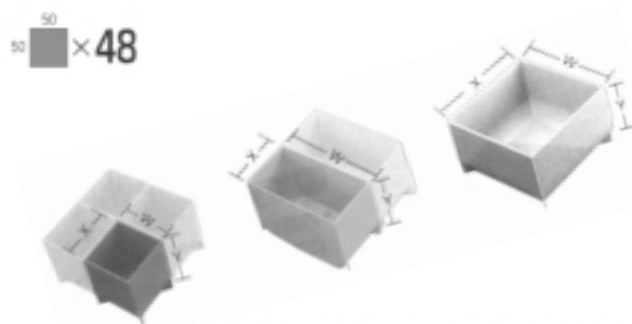

50 × 6
100 × 12



100 × 3
50 × 6

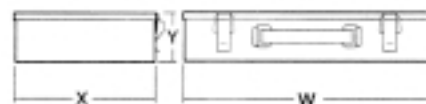

Order No	TB-A	TB-B	TB-C
TB33-A	24 Nos	-	-
TB33-B	-	12 Nos	-
TB33-C	-	6 Nos	-
TB33-D	12 Nos	6 Nos	-
TB33-E	-	6 Nos	-
TB33-F	8 Nos	4 Nos	2 Nos
TB34-A	48 Nos	48 Nos	-
TB34-B	-	-	-
TB34-C	-	-	12 Nos
TB34-D	24 Nos	24 Nos	-
TB34-E	-	-	6 Nos
TB34-F	16 Nos	16 Nos	4 Nos

Order No	W	X	Y
TB-A	50	50	55
TB-B	100	50	55
TB-C	100	100	55

Tool Box

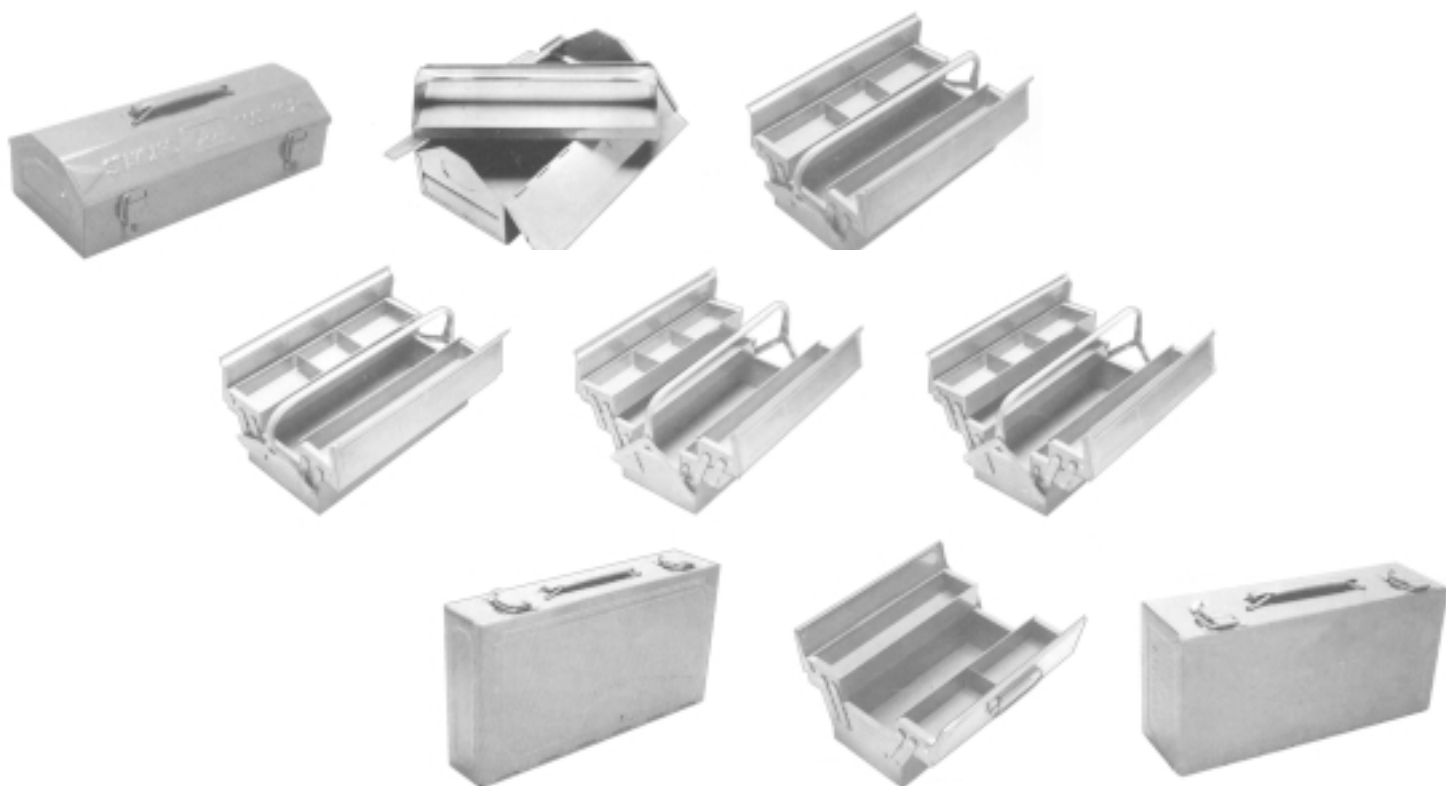

Order No	Length	Width	Height	Order No	Length	Width	Height	Order No	Length	Width	Height
09-01	360	150	105	09-02	400	180	160	09-03	450	200	160
09-04	530	200	160	09-05	450	200	210	09-06	530	200	210
09-07	460	200	125	09-08	350	160	160	09-09	360	200	75
								09-10	300	135	75
								09-11	310	150	95

Spring for Industrial and Household Appliance



We supply standard and special made - Spring for industrial and household appliance.

Spring material: • Aluminum • Bronze • Copper • Gold • Steel Alloy • Steel Surgical
• Steel Stainless • Silver • Titanium • Plastic • Plared Metal • Special Metal

